

RD16HHF1

RoHS Compliance, Silicon MOSFET Power Transistor 30MHz,16W

DESCRIPTION

RD16HHF1 is a MOS FET type transistor specifically designed for HF RF power amplifiers applications.

FEATURES

High power gain:

$P_{out} > 16W$, $G_p > 16dB$ @ $V_{ds} = 12.5V, f = 30MHz$

Integrated gate protection diode

APPLICATION

For output stage of high power amplifiers in HF band mobile radio sets.

RoHS COMPLIANT

RD16HHF1-501 is a RoHS compliant product.

RoHS compliance is indicated by the letter "G" after the lot marking.

This product includes the lead in high melting temperature type solders.

However, it is applicable to the following exceptions of RoHS Directives.

1. Lead in high melting temperature type solders (i.e. tin-lead solder alloys containing more than 85% lead.)

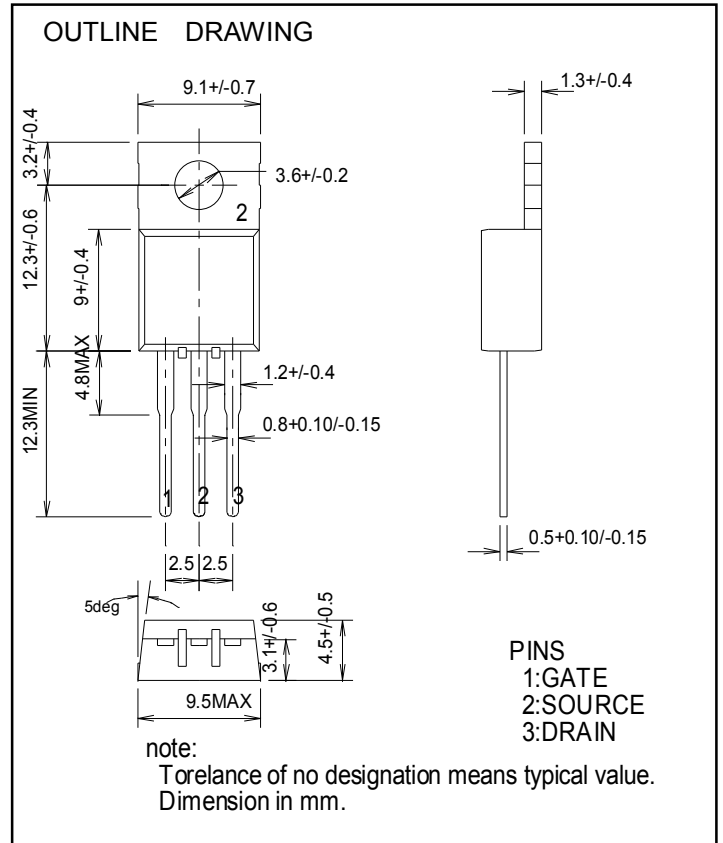

RD16HHF1

RoHS Compliance, Silicon MOSFET Power Transistor 30MHz,16W

ABSOLUTE MAXIMUM RATINGS

(Tc=25°C UNLESS OTHERWISE NOTED)

SYMBOL	PARAMETER	CONDITIONS	RATINGS	UNIT
V _{DSS}	Drain to source voltage	V _{gs} =0V	50	V
V _{GSS}	Gate to source voltage	V _{ds} =0V	-5 to +10	V
P _{ch}	Channel dissipation	T _c =25°C	56.8	W
P _{in}	Input power	Z _g =Z _l =50Ω	0.8	W
I _D	Drain to source current	-	5	A
T _{ch}	Channel temperature	-	150	°C
T _{stg}	Storage temperature	-	-40 to +150	°C
R _{th j-c}	Thermal resistance	junction to case	2.2	°C/W

Note 1: Above parameters are guaranteed independently.

ELECTRICAL CHARACTERISTICS (Tc=25°C , UNLESS OTHERWISE NOTED)

SYMBOL	PARAMETER	CONDITIONS	LIMITS			UNIT
			MIN	TYP	MAX.	
I _{DSS}	Zero gate voltage drain current	V _{ds} =17V, V _{gs} =0V	-	-	10	uA
I _{GSS}	Gate to source leak current	V _{gs} =10V, V _{ds} =0V	-	-	1	uA
V _{TH}	Gate threshold voltage	V _{ds} =12V, I _{ds} =1mA	1.7	-	4.7	V
P _{out}	Output power	V _{ds} =12.5V, P _{in} =0.4W,	16	19	-	W
η _D	Drain efficiency	f=30MHz, I _{dq} =0.5A	55	65	-	%
	Load VSWR tolerance	V _{ds} =15.2V, P _o =16W(Pin Control) f=30MHz, I _{dq} =0.5A, Z _g =50Ω Load VSWR=20:1(All Phase)	No destroy			-

Note : Above parameters , ratings , limits and conditions are subject to change.

RD16HHF1

RoHS Compliance, Silicon MOSFET Power Transistor 30MHz,16W

TYPICAL CHARACTERISTICS

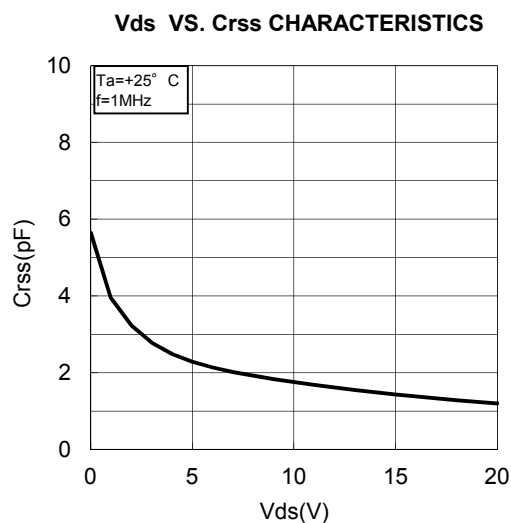
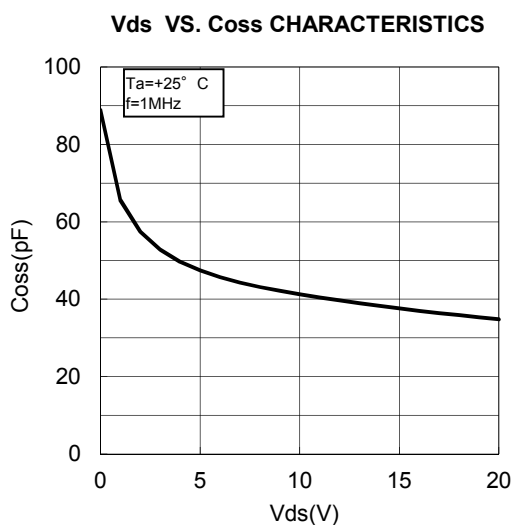
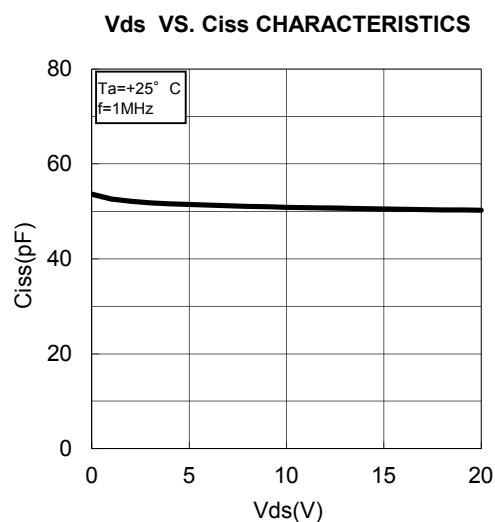
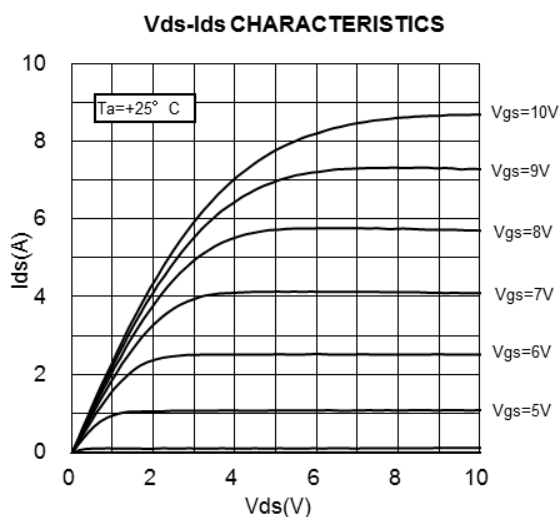
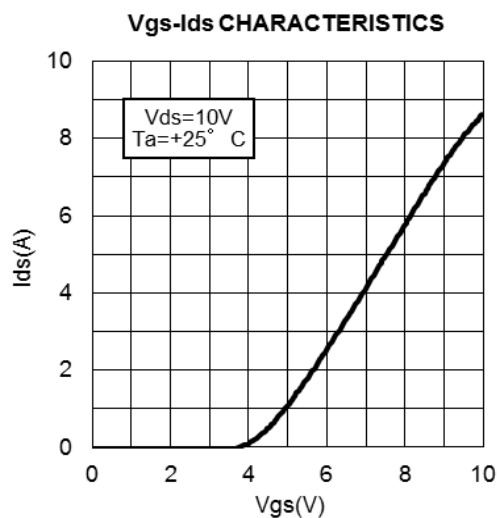
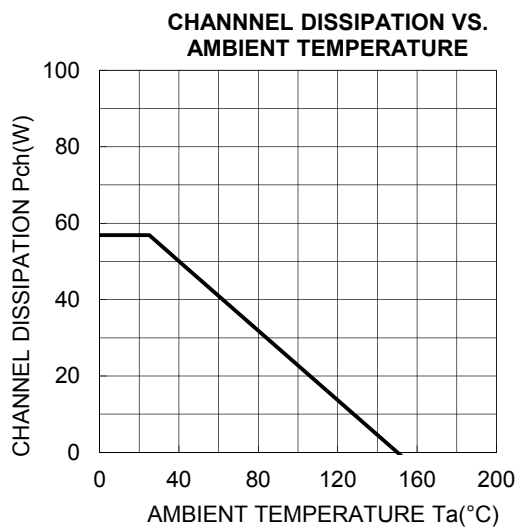

RD16HHF1

RoHS Compliance, Silicon MOSFET Power Transistor 30MHz,16W

TYPICAL CHARACTERISTICS

Pin-Po CHARACTERISTICS

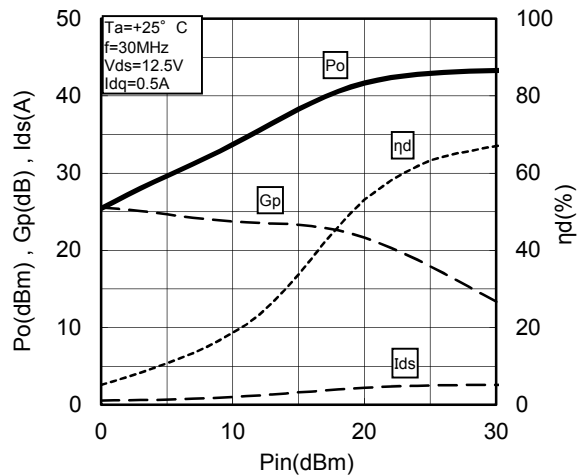

Pin-Po CHARACTERISTICS

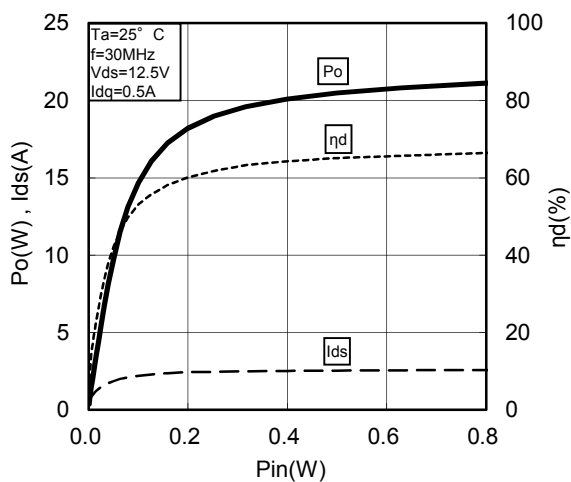

Vds-Po CHARACTERISTICS

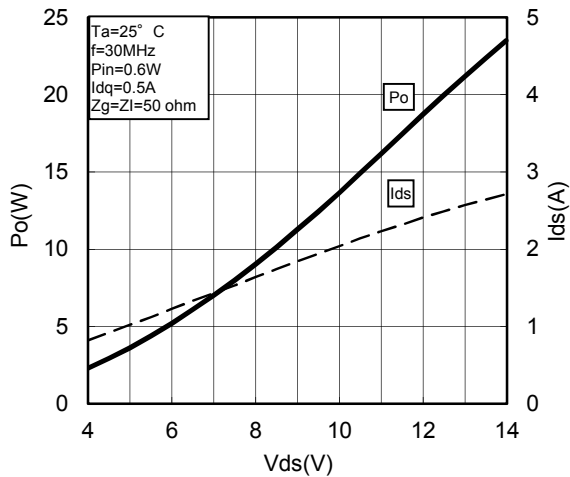

RD16HHF1

RoHS Compliance, Silicon MOSFET Power Transistor 30MHz,16W

TEST CIRCUIT(f=30MHz)

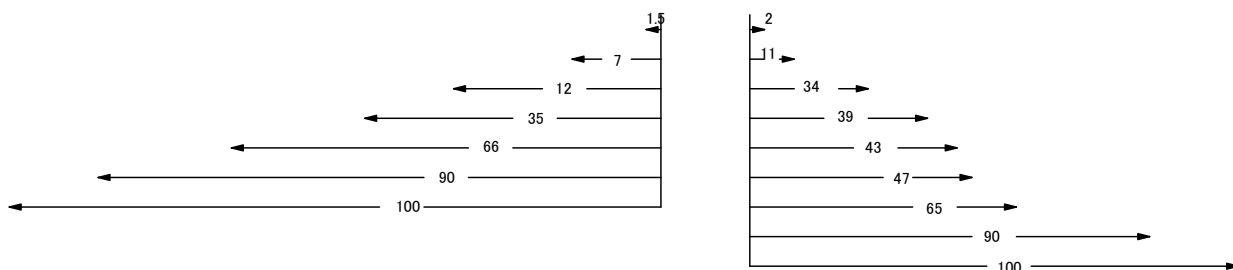
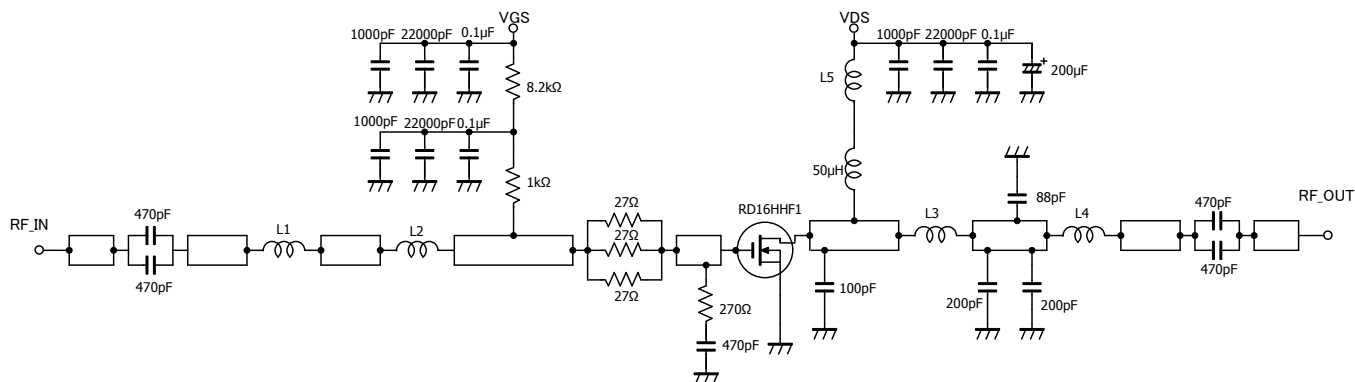

- L1 : 9Turns,I,D5.6mm,D0.9mm enamele wire
- L2 : 5Turns,I,D5.6mm,D0.9mm enamele wire
- L3 : 5Turns,I,D5.6mm,D0.9mm,P=1mm enamele wire
- L4 : 10Turns,I,D5.6mm,D0.9mm enamele wire
- L5 : 4Turns,I,D5.6mm,D0.9mm,P=1mm enamele wire

Dimensions : mm
 Note : Board material PTFE substrate
 micro strip line width=4.2mm/50Ω ,er=2.7,t=1.6mm

INPUT / OUTPUT IMPEDANCE VS. FREQUENCY CHARACTERISTICS

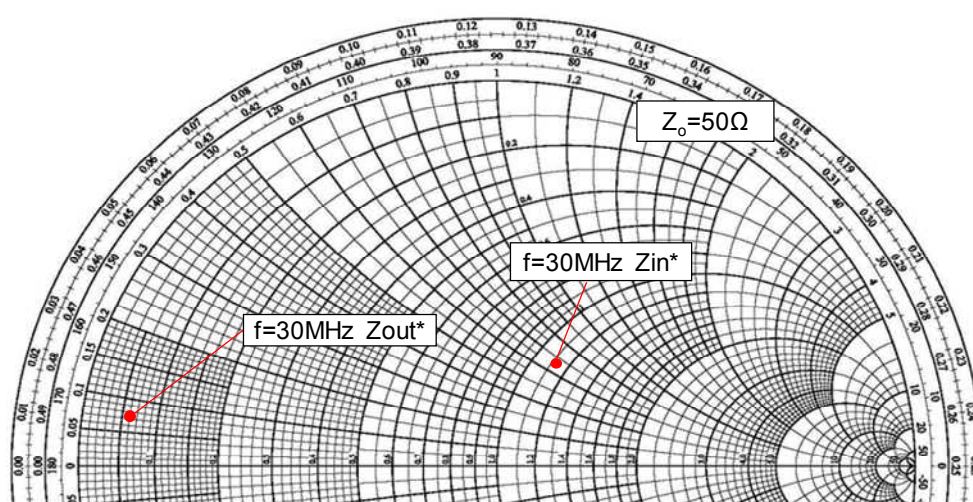

Zin , Zout				Conditions
f (MHz)	Zin* (Ω)	Zout* (Ω)		
30	58.55+j30.92	2.93+j3.51		Po=20W , Vds=12.5V , Pin=0.4W

Zin* : Complex conjugate of input impedance

Zout* : Complex conjugate of input impedance

RD16HHF1

RoHS Compliance, Silicon MOSFET Power Transistor 30MHz,16W

RD16HHF1 S-PARAMETER DATA (@Vds=12.5V, Id=500mA)

Freq. [MHz]	S11		S21		S12		S22	
	(mag)	(ang)	(mag)	(ang)	(mag)	(ang)	(mag)	(ang)
30	0.786	-107.5	52.246	117.6	0.017	37.8	0.540	-89.0
40	0.708	-120.6	40.758	106.9	0.017	30.4	0.521	-107.7
50	0.669	-129.4	33.102	99.5	0.017	27.3	0.516	-118.9
60	0.648	-135.6	27.688	93.8	0.017	25.4	0.516	-126.7
70	0.638	-139.9	23.761	89.2	0.017	25.2	0.521	-131.8
80	0.634	-143.3	20.737	85.2	0.016	25.0	0.527	-135.8
90	0.634	-146.1	18.350	81.6	0.016	26.6	0.536	-138.7
100	0.637	-148.3	16.405	78.3	0.016	28.4	0.545	-141.0
125	0.650	-152.5	12.830	71.1	0.015	36.0	0.574	-145.3
150	0.667	-155.5	10.443	65.0	0.015	47.4	0.606	-148.4
175	0.687	-158.0	8.723	59.3	0.016	58.1	0.632	-151.4
200	0.708	-160.4	7.390	54.0	0.018	68.4	0.664	-154.5
250	0.746	-164.7	5.529	44.9	0.025	80.2	0.718	-158.8
300	0.780	-168.7	4.302	36.4	0.034	85.1	0.758	-164.6
350	0.808	-172.6	3.449	29.6	0.045	86.2	0.803	-168.2
400	0.833	-176.3	2.802	22.5	0.055	84.5	0.826	-174.6
450	0.852	-179.8	2.341	17.2	0.066	82.8	0.853	-177.5
500	0.869	176.6	1.949	11.5	0.075	80.0	0.854	176.7
550	0.881	173.4	1.682	7.3	0.087	77.7	0.876	174.6
600	0.892	170.0	1.428	3.1	0.096	74.8	0.870	169.2
650	0.899	167.0	1.266	-0.3	0.108	71.8	0.894	167.0
700	0.907	163.8	1.101	-3.8	0.117	68.8	0.891	161.2
750	0.913	160.9	1.000	-7.3	0.130	65.4	0.904	158.9
800	0.919	157.7	0.876	-9.7	0.138	62.7	0.898	153.7
850	0.924	154.8	0.800	-13.1	0.150	58.7	0.912	150.9
900	0.927	151.7	0.715	-14.8	0.157	56.3	0.905	145.7
950	0.930	148.9	0.659	-18.4	0.168	51.6	0.902	142.3
1000	0.932	145.8	0.599	-18.8	0.175	49.7	0.906	137.4

RD16HHF1

RoHS Compliance, Silicon MOSFET Power Transistor 30MHz,16W

ATTENTION:

- 1.High Temperature ; This product might have a heat generation while operation,Please take notice that have a possibility to receive a burn to touch the operating product directly or touch the product until cold after switch off. At the near the product,do not place the combustible material that have possibilities to arise the fire.
- 2.Generation of High Frequency Power ; This product generate a high frequency power. Please take notice that do not leakage the unnecessary electric wave and use this products without cause damage for human and property per normal operation.
- 3.Before use; Before use the product,Please design the equipment in consideration of the risk for human and electric wave obstacle for equipment.

PRECAUTIONS FOR THE USE OF MITSUBISHI SILICON RF POWER DEVICES:

1. The specifications of mention are not guarantee values in this data sheet. Please confirm additional details regarding operation of these products from the formal specification sheet. For copies of the formal specification sheets, please contact one of our sales offices.
- 2.RA series products (RF power amplifier modules) and RD series products (RF power transistors) are designed for consumer mobile communication terminals and were not specifically designed for use in other applications. In particular, while these products are highly reliable for their designed purpose, they are not manufactured under a quality assurance testing protocol that is sufficient to guarantee the level of reliability typically deemed necessary for critical communications elements and In the application, which is base station applications and fixed station applications that operate with long term continuous transmission and a higher on-off frequency during transmitting, please consider the derating, the redundancy system, appropriate setting of the maintain period and others as needed. For the reliability report which is described about predicted operating life time of Mitsubishi Silicon RF Products , please contact Mitsubishi Electric Corporation or an authorized Mitsubishi Semiconductor product distributor.
3. RD series products use MOSFET semiconductor technology. They are sensitive to ESD voltage therefore appropriate ESD precautions are required.
4. In the case of use in below than recommended frequency, there is possibility to occur that the device is deteriorated or destroyed due to the RF-swing exceed the breakdown voltage.
5. In order to maximize reliability of the equipment, it is better to keep the devices temperature low. It is recommended to utilize a sufficient sized heat-sink in conjunction with other cooling methods as needed (fan, etc.) to keep the channel temperature for RD series products lower than 120deg/C(in case of Tchmax=150deg/C) ,140deg/C(in case of Tchmax=175deg/C) under standard conditions.
6. Do not use the device at the exceeded the maximum rating condition. In case of plastic molded devices, the exceeded maximum rating condition may cause blowout, smoldering or catch fire of the molding resin due to extreme short current flow between the drain and the source of the device. These results causes in fire or injury.
7. For specific precautions regarding assembly of these products into the equipment, please refer to the supplementary items in the specification sheet.
8. Warranty for the product is void if the products protective cap (lid) is removed or if the product is modified in any way from it's original form.
9. For additional "Safety first" in your circuit design and notes regarding the materials, please refer the last page of this data sheet.

RD16HHF1

RoHS Compliance, Silicon MOSFET Power Transistor 30MHz,16W

10. Please avoid use in the place where water or organic solvents can adhere directly to the product and the environments with the possibility of caustic gas, dust, salinity, etc. Reliability could be markedly decreased and also there is a possibility failures could result causing a serious accident. Likewise, there is a possibility of causing a serious accident if used in an explosive gas environment. Please allow for adequate safety margin in your designs.

11. Please refer to the additional precautions in the formal specification sheet.

Keep safety first in your circuit designs!

Mitsubishi Electric Corporation puts the maximum effort into making semiconductor products better and more reliable, but there is always the possibility that trouble may occur with them. Trouble with semiconductors may lead to personal injury, fire or property damage. Remember to give due consideration to safety when making your circuit designs, with appropriate measures such as (i) placement of substitutive, auxiliary circuits, (ii) use of non-flammable material or (iii) prevention against any malfunction or mishap.

Notes regarding these materials

- These materials are intended as a reference to assist our customers in the selection of the Mitsubishi semiconductor product best suited to the customer's application; they do not convey any license under any intellectual property rights, or any other rights, belonging to Mitsubishi Electric Corporation or a third party.
- Mitsubishi Electric Corporation assumes no responsibility for any damage, or infringement of any third-party's rights, originating in the use of any product data, diagrams, charts, programs, algorithms, or circuit application examples contained in these materials.
- All information contained in these materials, including product data, diagrams, charts, programs and algorithms represents information on products at the time of publication of these materials, and are subject to change by Mitsubishi Electric Corporation without notice due to product improvements or other reasons. It is therefore recommended that customers contact Mitsubishi Electric Corporation or an authorized Mitsubishi Semiconductor product distributor for the latest product information before purchasing a product listed herein.
The information described here may contain technical inaccuracies or typographical errors. Mitsubishi Electric Corporation assumes no responsibility for any damage, liability, or other loss rising from these inaccuracies or errors.
Please also pay attention to information published by Mitsubishi Electric Corporation by various means, including the Mitsubishi Semiconductor home page (<http://www.MitsubishiElectric.com/>).
- When using any or all of the information contained in these materials, including product data, diagrams, charts, programs, and algorithms, please be sure to evaluate all information as a total system before making a final decision on the applicability of the information and products. Mitsubishi Electric Corporation assumes no responsibility for any damage, liability or other loss resulting from the information contained herein.
- Mitsubishi Electric Corporation semiconductors are not designed or manufactured for use in a device or system that is used under circumstances in which human life is potentially at stake. Please contact Mitsubishi Electric Corporation or an authorized Mitsubishi Semiconductor product distributor when considering the use of a product contained herein for any specific purposes, such as apparatus or systems for transportation, vehicular, medical, aerospace, nuclear, or undersea repeater use.
- The prior written approval of Mitsubishi Electric Corporation is necessary to reprint or reproduce in whole or in part these materials.
- If these products or technologies are subject to the Japanese export control restrictions, they must be exported under a license from the Japanese government and cannot be imported into a country other than the approved destination.
Any diversion or re-export contrary to the export control laws and regulations of Japan and/or the country of destination is prohibited.
- Please contact Mitsubishi Electric Corporation or an authorized Mitsubishi Semiconductor product distributor for further details on these materials or the products contained therein.